

65V N-Ch Power MOSFET

Feature

- ◇ High Speed Power Smooth Switching
- ◇ Enhanced Body diode dv/dt capability
- ◇ Enhanced Avalanche Ruggedness
- ◇ 100% UIS Tested, 100% Rg Tested
- ◇ Lead Free

Application

- ◇ Synchronous Rectification in SMPS
- ◇ Hard Switching and High Speed Circuit
- ◇ Power Tools
- ◇ UPS
- ◇ Motor Control

V_{DS}	65	V
$R_{DS(on),typ}$	0.78	m Ω
I_D (Silicon Limited)	506	A
I_D (Package Limited)	240	A

Part Number	Package	Marking
HGB009NE6A	TO-263	GB009NE6A

TO-263-7

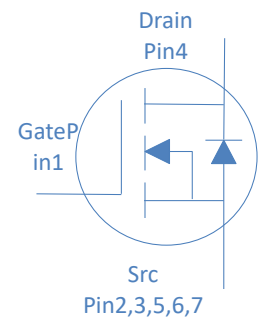
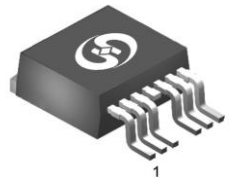

Absolute Maximum Ratings at $T_j=25^\circ\text{C}$ (unless otherwise specified)

Parameter	Symbol	Conditions	Value	Unit
Continuous Drain Current (Silicon Limited)	I_D	$T_C=25^\circ\text{C}$	506	A
		$T_C=100^\circ\text{C}$	358	
		$T_C=25^\circ\text{C}$	240	
Continuous Drain Current (Package Limited)		$T_C=25^\circ\text{C}$	240	
Drain to Source Voltage	V_{DS}	-	65	V
Gate to Source Voltage	V_{GS}	-	± 20	V
Pulsed Drain Current	I_{DM}	-	1950	A
Avalanche Energy, Single Pulse	E_{AS}	$L=0.4\text{mH}, T_C=25^\circ\text{C}$	720	mJ
Power Dissipation	P_D	$T_C=25^\circ\text{C}$	429	W
Operating and Storage Temperature	T_J, T_{stg}	-	-55 to 175	$^\circ\text{C}$

Absolute Maximum Ratings

Parameter	Symbol	Max	Unit
Thermal Resistance Junction-Case	$R_{\theta JC}$	0.35	$^\circ\text{C/W}$
Thermal Resistance Junction-Ambient	$R_{\theta JA}$	60	$^\circ\text{C/W}$

Electrical Characteristics at $T_J=25^{\circ}\text{C}$ (unless otherwise specified)
Static Characteristics

Parameter	Symbol	Conditions	Value			Unit
			min	typ	max	
Drain to Source Breakdown Voltage	$V_{(BR)DSS}$	$V_{GS}=0V, I_D=250\mu A$	65	-	-	V
Gate Threshold Voltage	$V_{GS(th)}$	$V_{GS}=V_{DS}, I_D=250\mu A$	2	2.6	4	
Zero Gate Voltage Drain Current	I_{DSS}	$V_{GS}=0V, V_{DS}=60V, T_J=25^{\circ}\text{C}$	-	-	1	μA
		$V_{GS}=0V, V_{DS}=60V, T_J=100^{\circ}\text{C}$	-	-	100	
Gate to Source Leakage Current	I_{GSS}	$V_{GS}=\pm 20V, V_{DS}=0V$	-	-	± 100	nA
Drain to Source on Resistance	$R_{DS(on)}$	$V_{GS}=10V, I_D=20A$	-	0.78	0.95	$m\Omega$
Transconductance	g_{fs}	$V_{DS}=5V, I_D=20A$	-	85	-	S
Gate Resistance	R_G	$V_{GS}=0V, V_{DS}$ Open, $f=1\text{MHz}$	-	0.7	-	Ω

Dynamic Characteristics

Input Capacitance	C_{iss}	$V_{GS}=0V, V_{DS}=30V, f=1\text{MHz}$	-	18330	-	pF
Output Capacitance	C_{oss}		-	6011	-	
Reverse Transfer Capacitance	C_{rss}		-	347	-	
Total Gate Charge	Q_g	$V_{DD}=30V, I_D=20A, V_{GS}=10V$	-	280	-	nC
Gate to Source Charge	Q_{gs}		-	58	-	
Gate to Drain (Miller) Charge	Q_{gd}		-	60	-	
Turn on Delay Time	$t_{d(on)}$	$V_{DD}=30V, I_D=20A, V_{GS}=10V, R_G=10\Omega,$	-	34	-	ns
Rise time	t_r		-	32	-	
Turn off Delay Time	$t_{d(off)}$		-	74	-	
Fall Time	t_f		-	26	-	

Reverse Diode Characteristics

Diode Forward Voltage	V_{SD}	$V_{GS}=0V, I_F=20A$	-	0.9	-	V
Reverse Recovery Time	t_{rr}	$V_R=30V, I_F=20A, di_F/dt=100A/\mu s$	-	102	-	ns
Reverse Recovery Charge	Q_{rr}		-	213	-	nC

Fig 1. Typical Output Characteristics

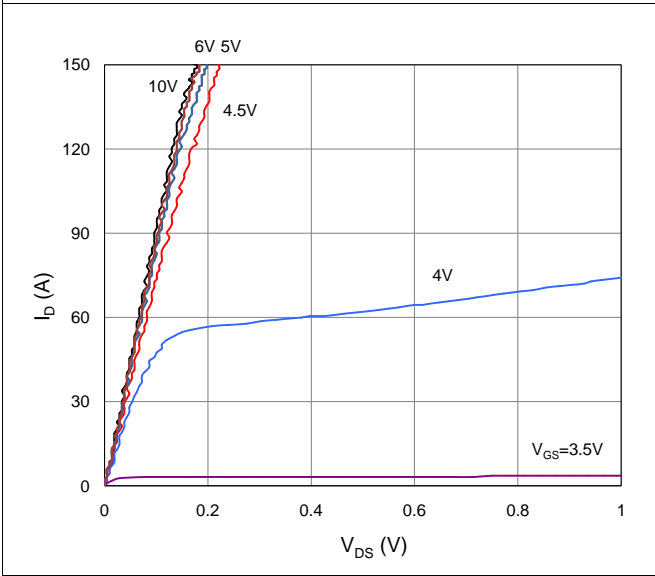

Figure 2. On-Resistance vs. Gate-Source Voltage

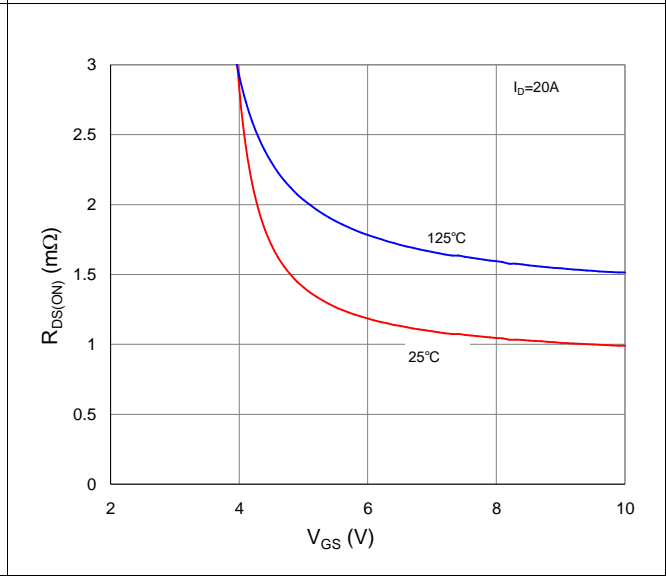

Figure 3. On-Resistance vs. Drain Current and Gate Voltage

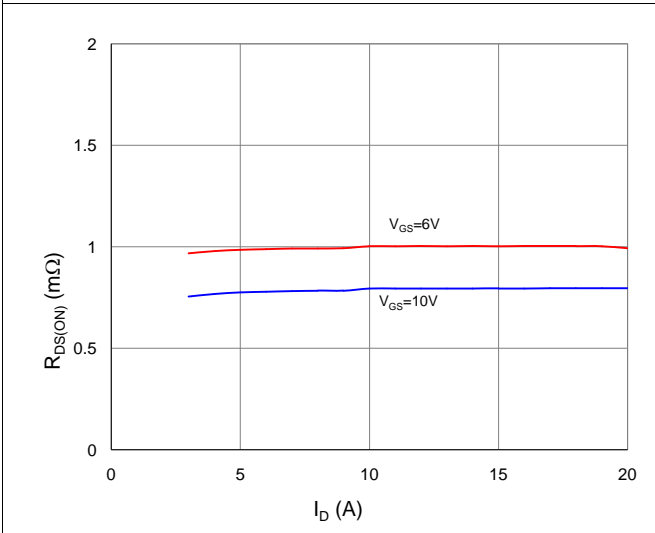

Figure 4. Normalized On-Resistance vs. Junction Temperature

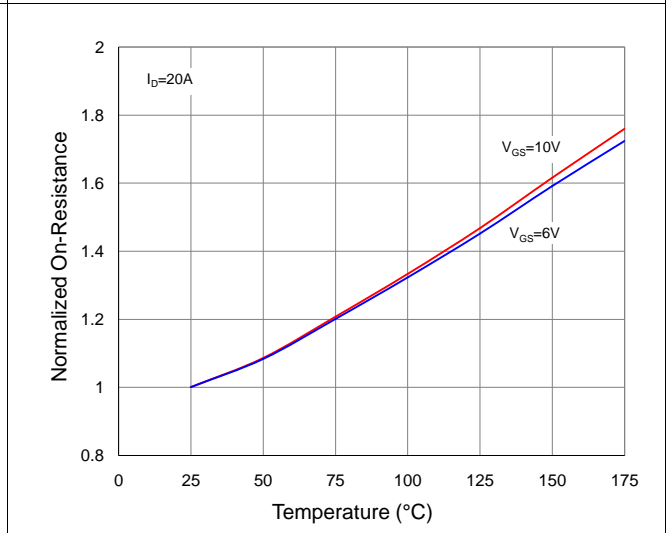

Figure 5. Typical Transfer Characteristics

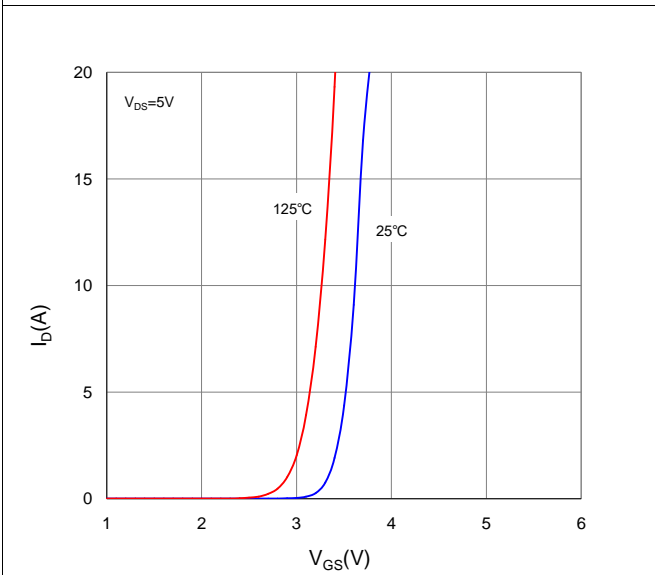

Figure 6. Typical Source-Drain Diode Forward Voltage

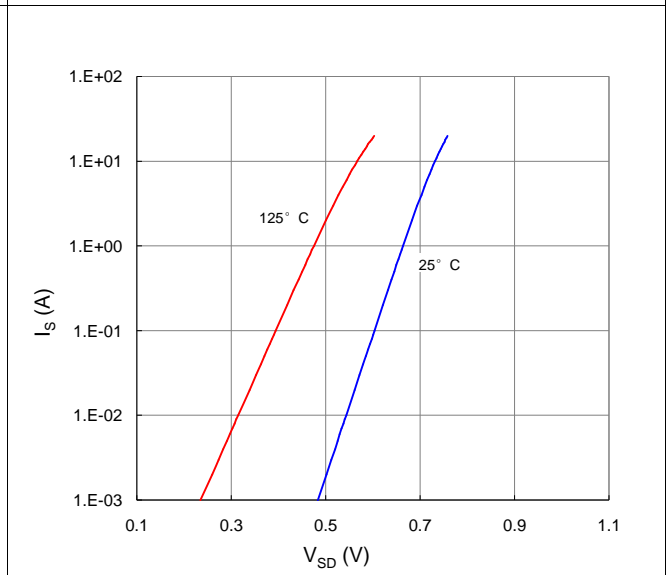

Figure 7. Typical Gate-Charge vs. Gate-to-Source Voltage

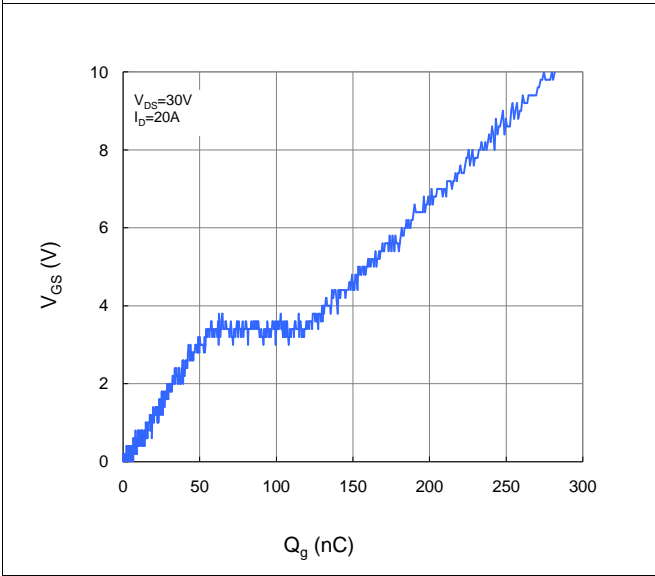

Figure 8. Typical Capacitance vs. Drain-to-Source Voltage

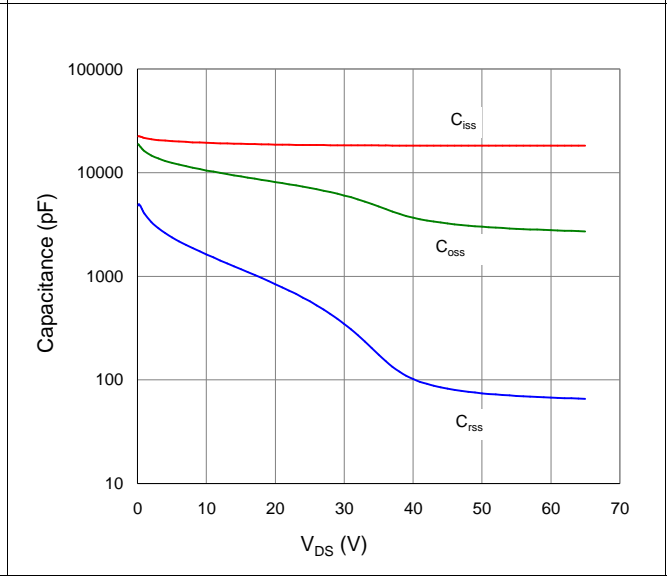

Figure 9. Maximum Safe Operating Area

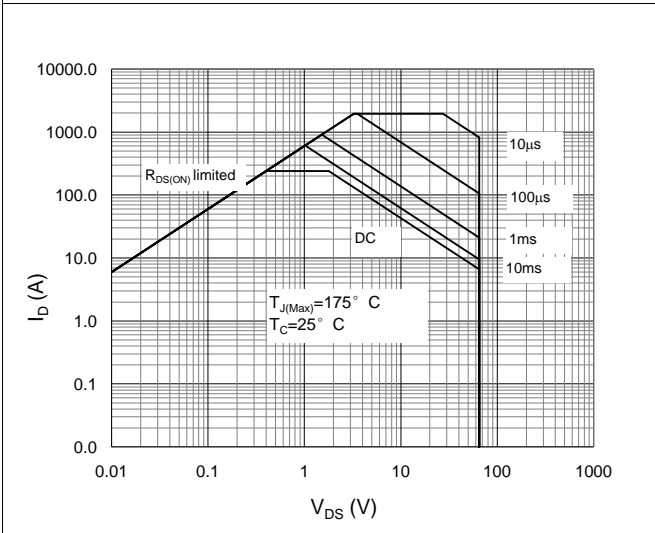

Figure 10. Maximum Drain Current vs. Case Temperature

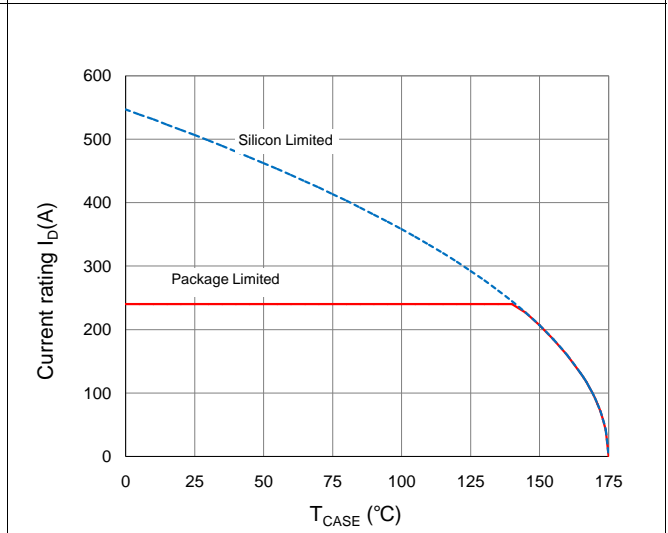
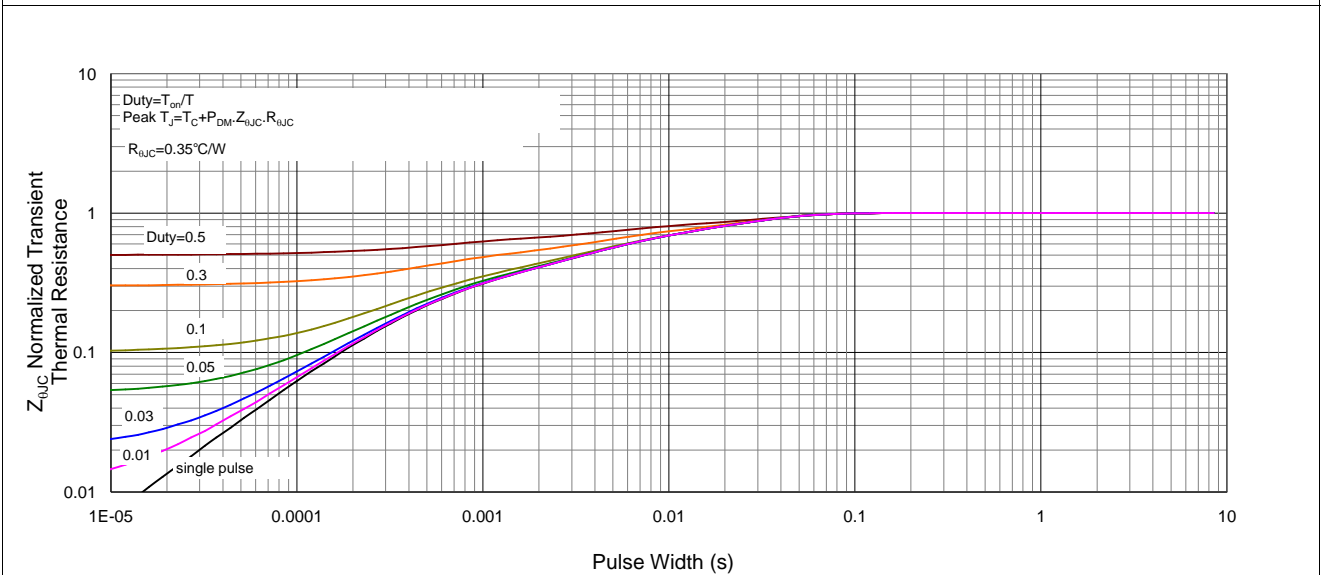
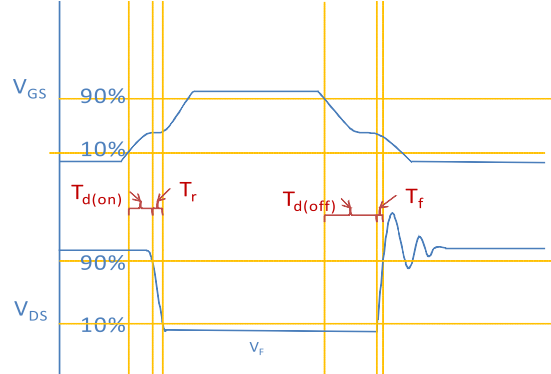
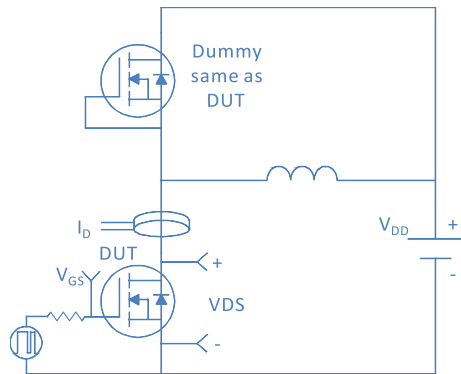

Figure 11. Normalized Maximum Transient Thermal Impedance, Junction-to-Case



Inductive switching Test



Gate Charge Test

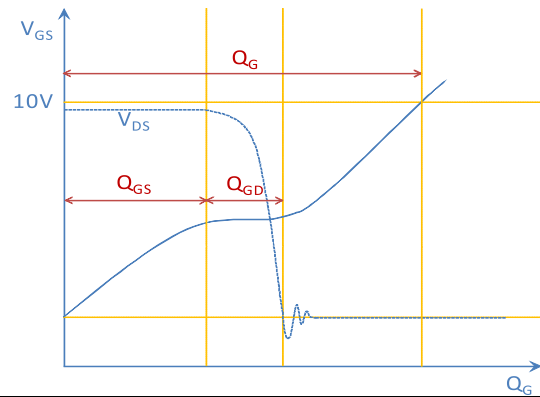
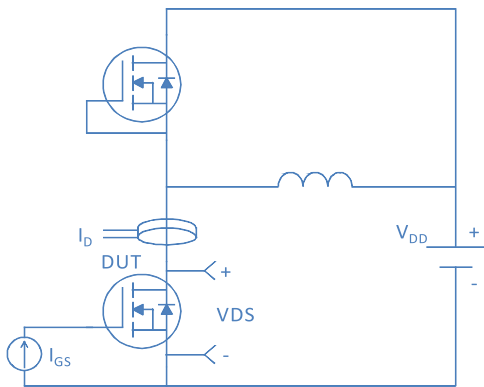

Unclamped Inductive Switching (UIS) Test

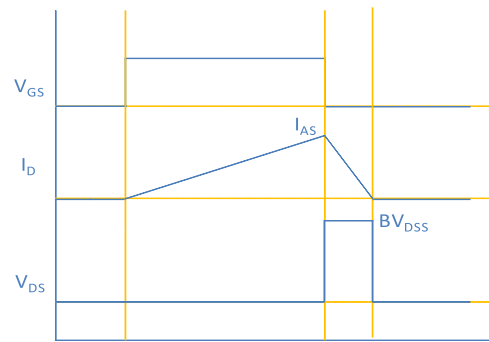
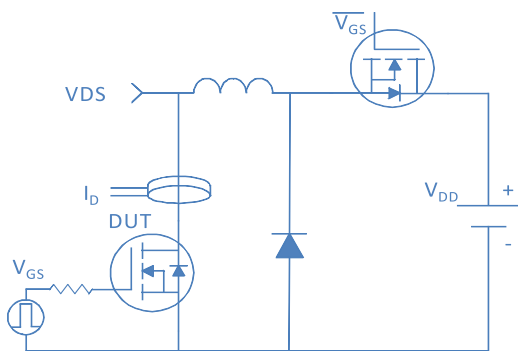

Diode Recovery Test

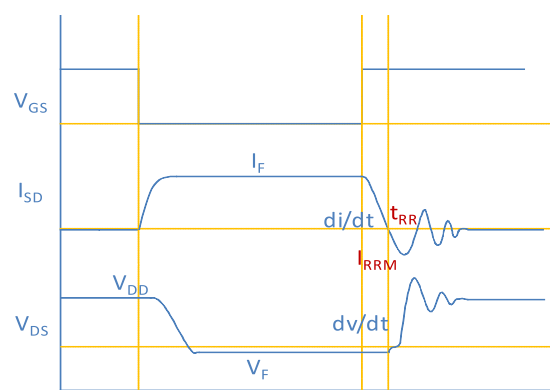
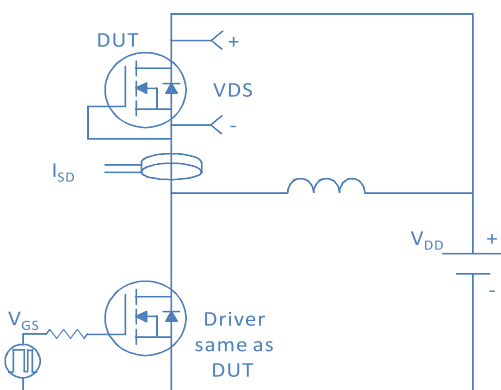

TO-263-7, 7 leads

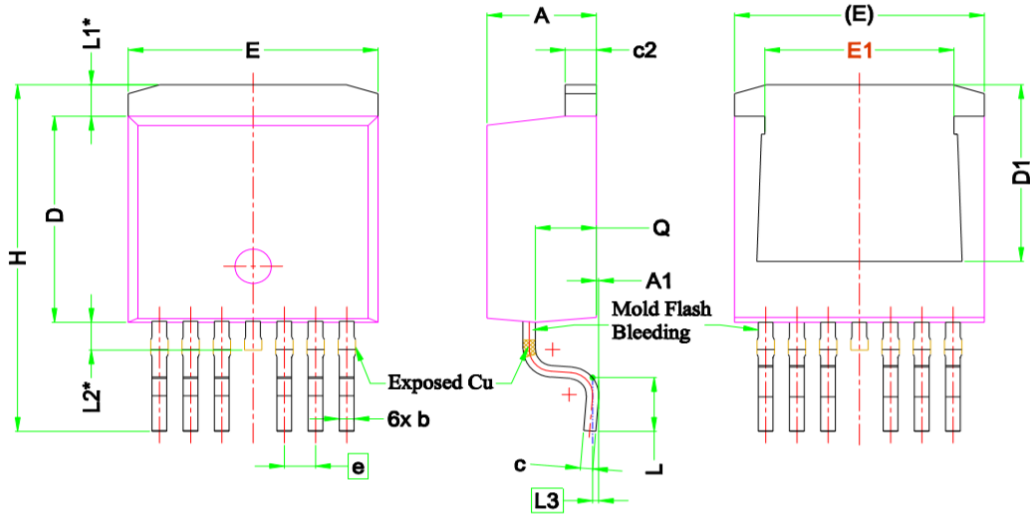

SYMBOL	DIMENSIONS		
	MIN.	NOM.	MAX.
A	4.24	4.44	4.64
A1	0.00	0.10	0.25
b	0.50	0.60	0.70
c	0.40	0.50	0.60
c2	1.15	1.27	1.40
D	8.82	8.92	9.02
D1	6.86	7.65	—
E	9.96	10.16	10.36
E1	6.89	7.77	7.89
e	1.27 BSC		
H	14.61	15.00	15.88
L	1.78	2.32	2.79
L1	1.36 REF.		
L2	1.20 REF.		
L3	0.25 BSC		
Q	2.30	2.48	2.70